

UTSTÄLLNINGAR



Separatutställning våren 1984

Kvinnor och TEKO

textilkonstnär katrin bawah

Kvinnor och TEKO

Arbetskraftsreserven

Kvinnoarbete

Rädda Svensk Teko

Att orka - att hinna

Köp Svenska Kläder

Kollektivet

Modekarusellen

Fabriksflickor

”ARBETSKRAFTSRESERVEN”

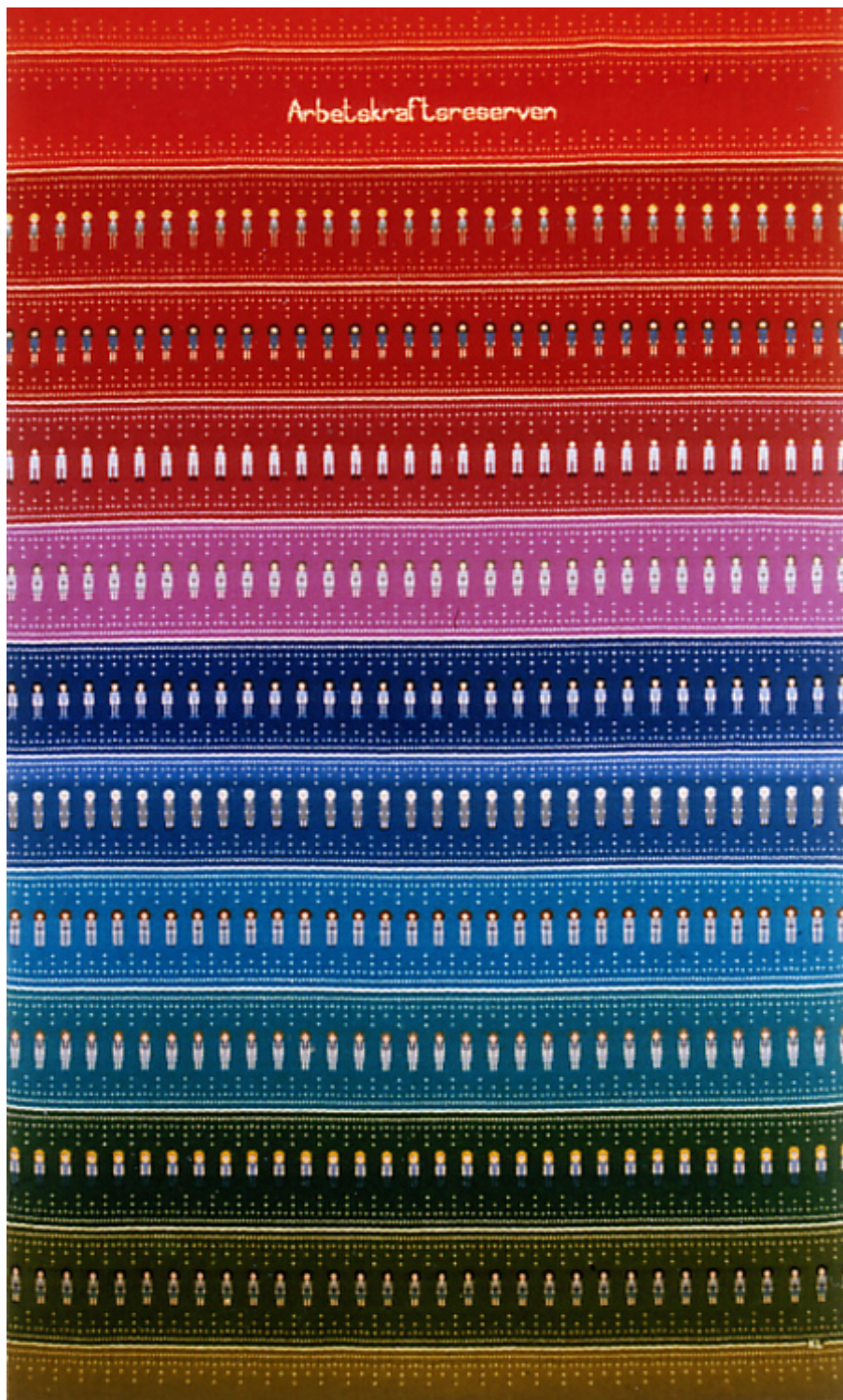

Kvinnor och TEKO

textilkonstnär katrin bawah

"ARBETSKRAFTSRESERVEN"

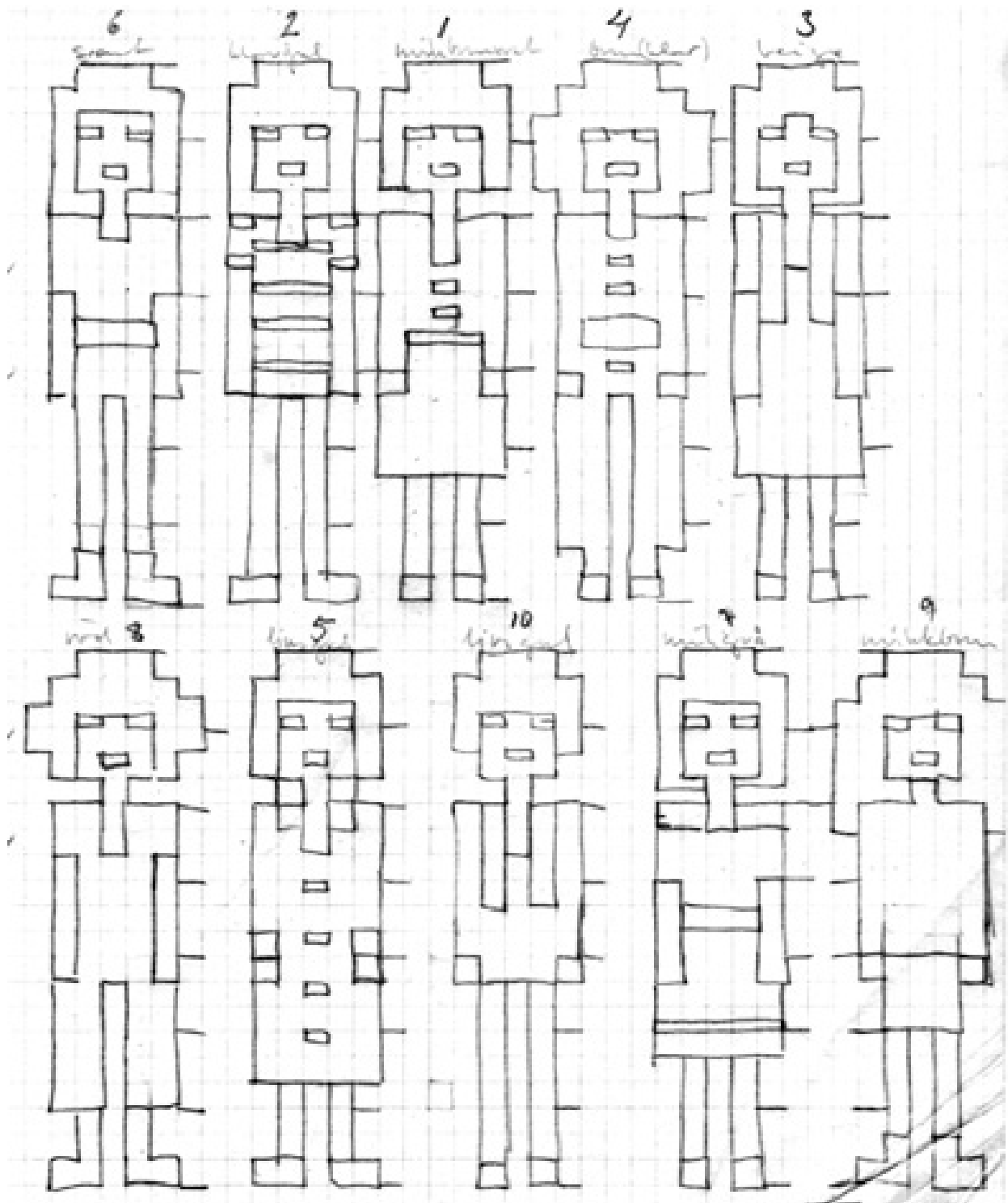

Kvinnor och TEKO

textilkonstnär katrin bawah

”KVINNOARBETE”



Kvinnor och TEKO

textilkonstnär katrin bawah

"KVINNOARBETE"

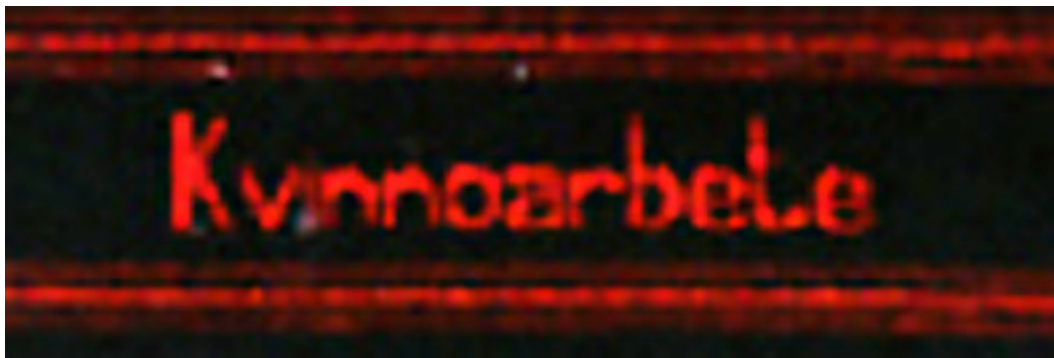

Kvinnor och TEKO

textilkonstnär katrin bawah

”KVINNOARBETE”

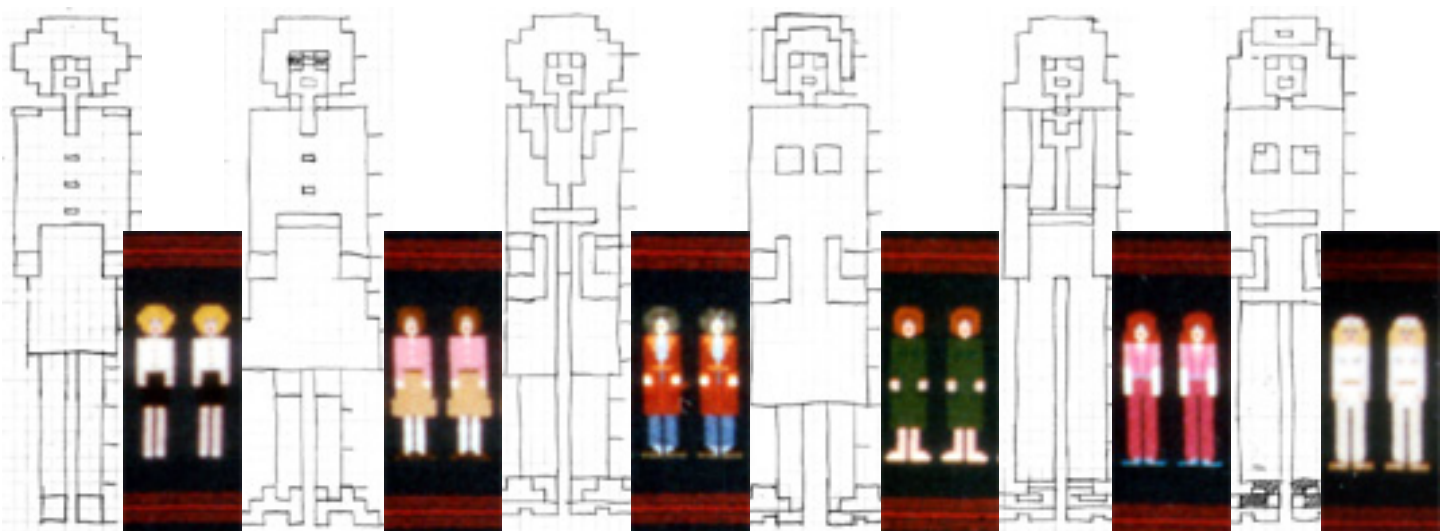
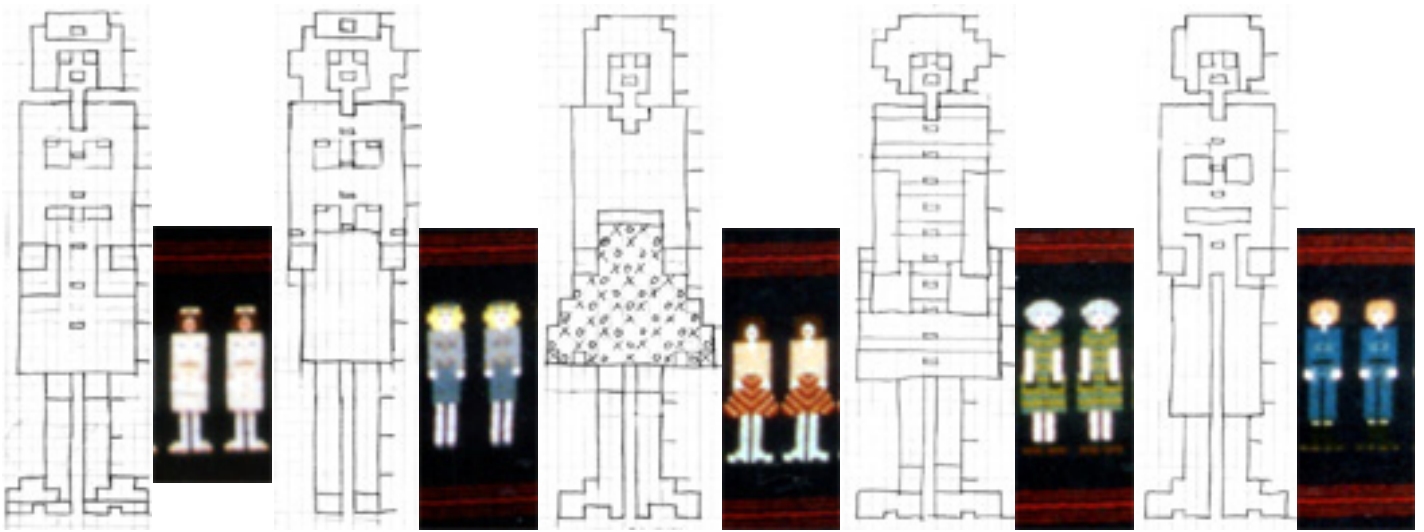

Kvinnor och TEKO

textilkonstnär katrin bawah

”RÄDDA SVENSK TEKO”



Kvinnor och TEKO

textilkonstnär katrin bawah

”Att Orka - Att Hinna, Familjen”



Kvinnor och TEKO

textilkonstnär katrin bawah

”Att Orka - Att Hinna, Jobbet”



Kvinnor och TEKO

textilkonstnär katrin bawah

”Att Orka - Att Hinna, Fritiden”



Kvinnor och TEKO

textilkonstnär katrin bawah

”KÖP SVENSKA KLÄDER”

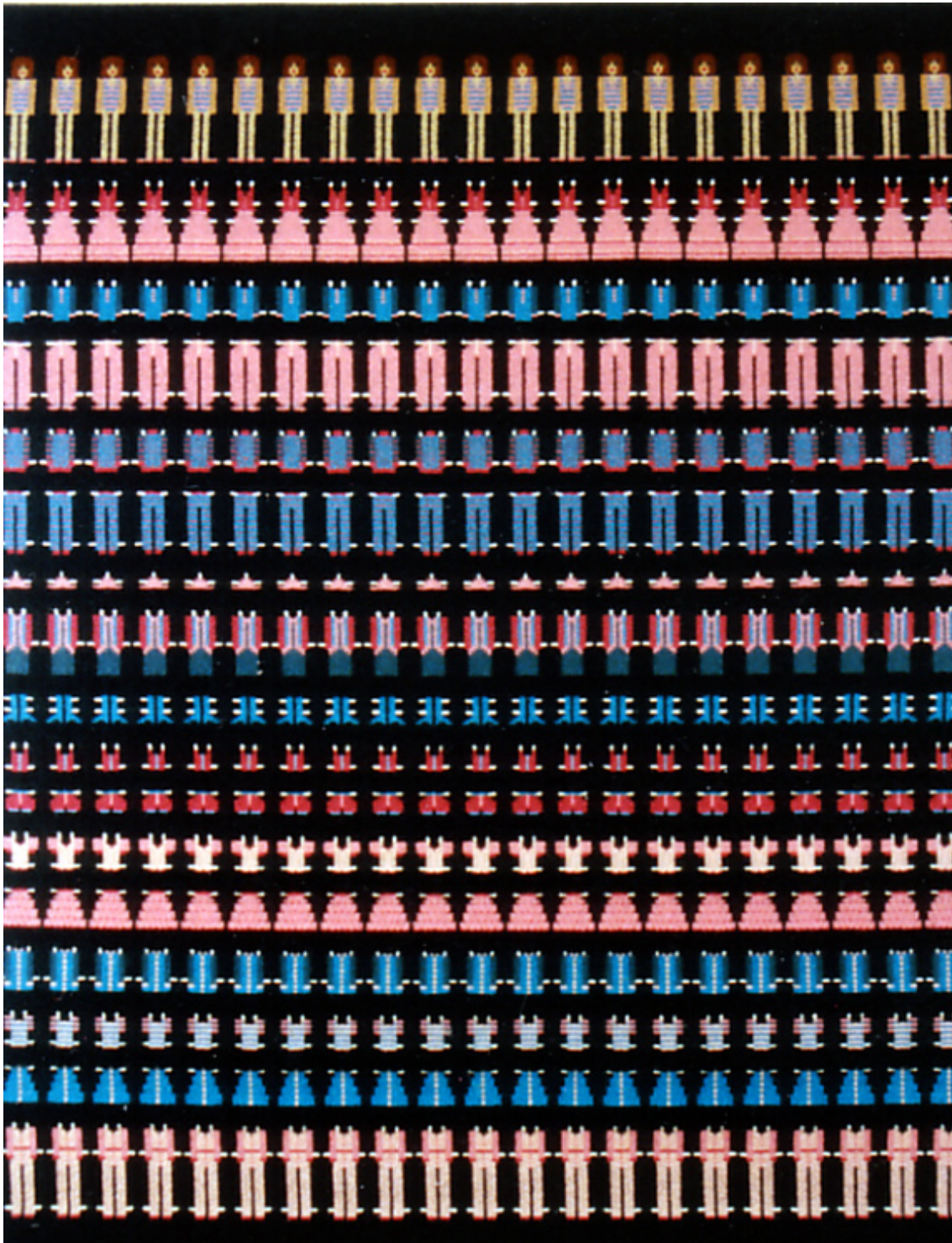

Kvinnor och TEKO

textilkonstnär katrin bawah

"KÖP SVENSKA KLÄDER"

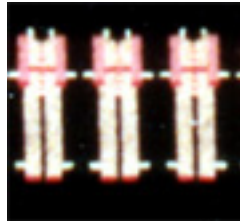
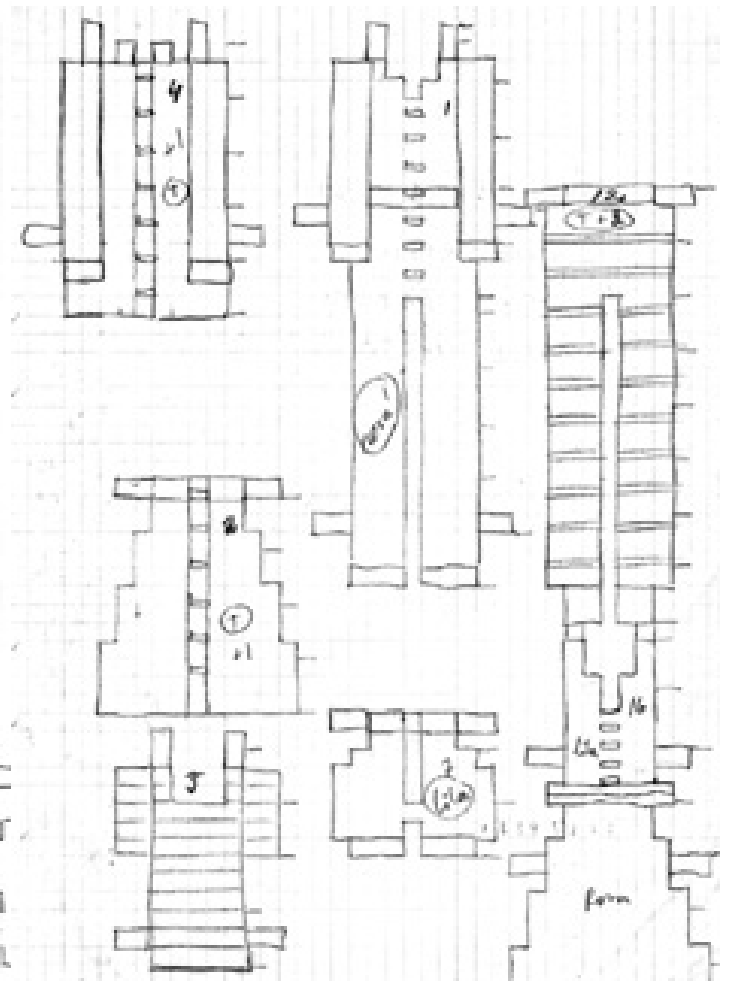
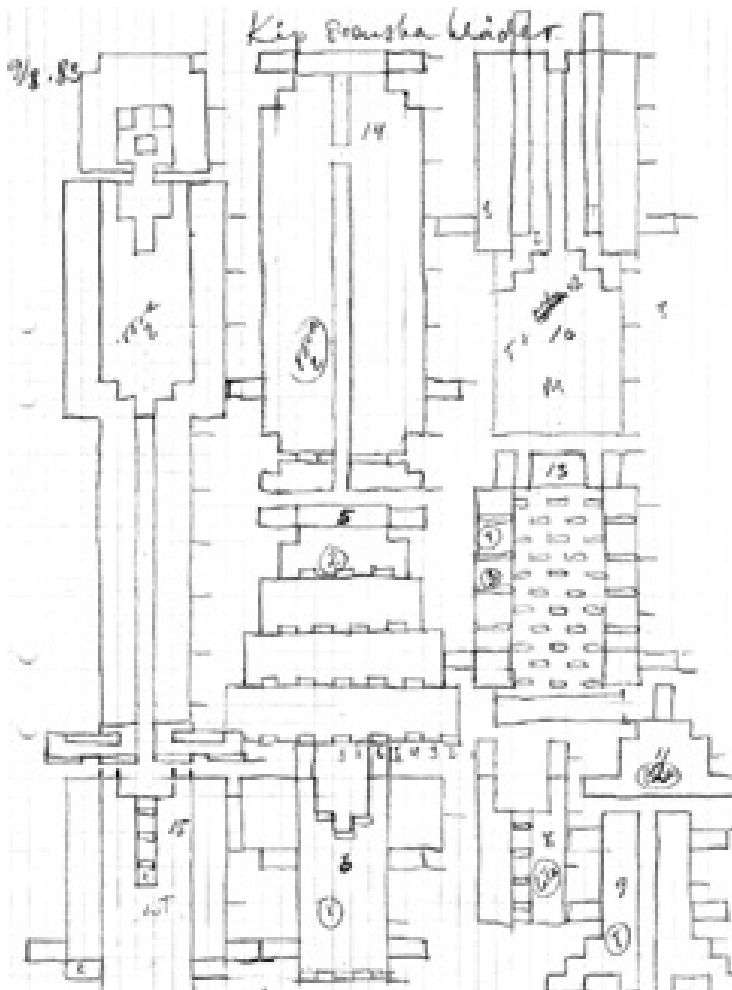
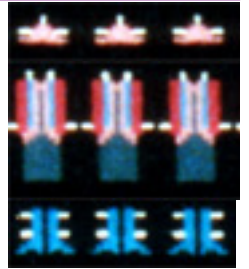
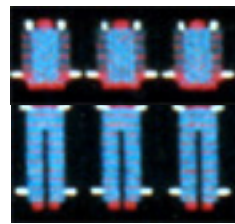
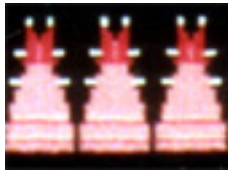
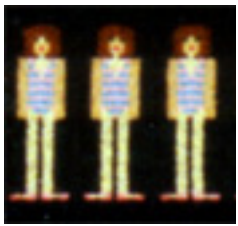

Kvinnor och TEKNO

textilkonstnär katrin bawah

”KOLLEKTIVET”



Kvinnor och TEKO

textilkonstnär katrin bawah

”MODEKARUSELLEN”

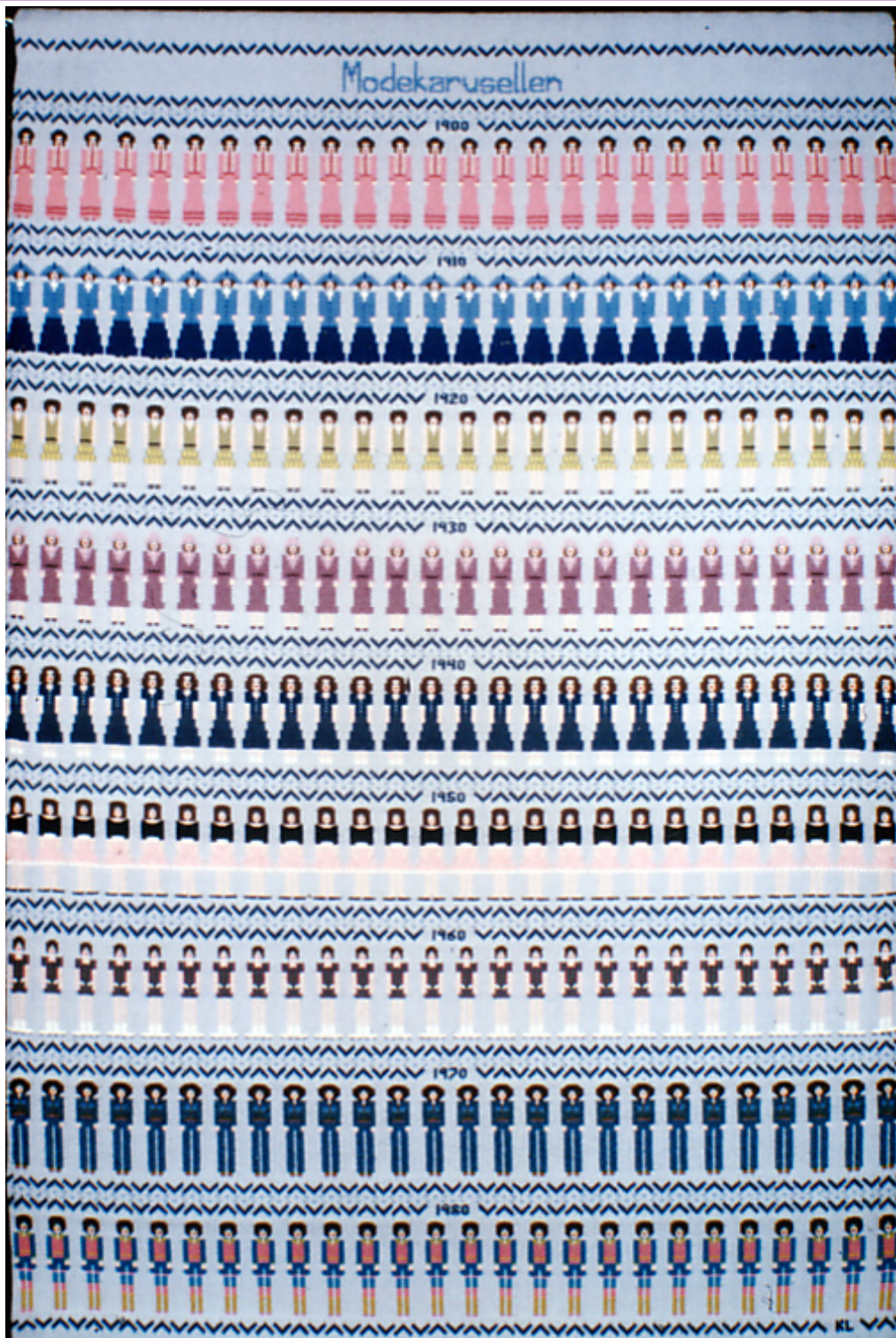

Kvinnor och TEKO

textilkonstnär katrin bawah

"MODEKARUSELLEN"

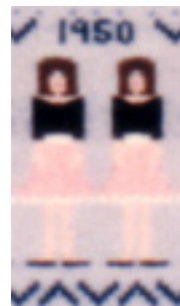

Kvinnor och TEKO

textilkonstnär katrin bawah

”FABRIKSFLICKOR”

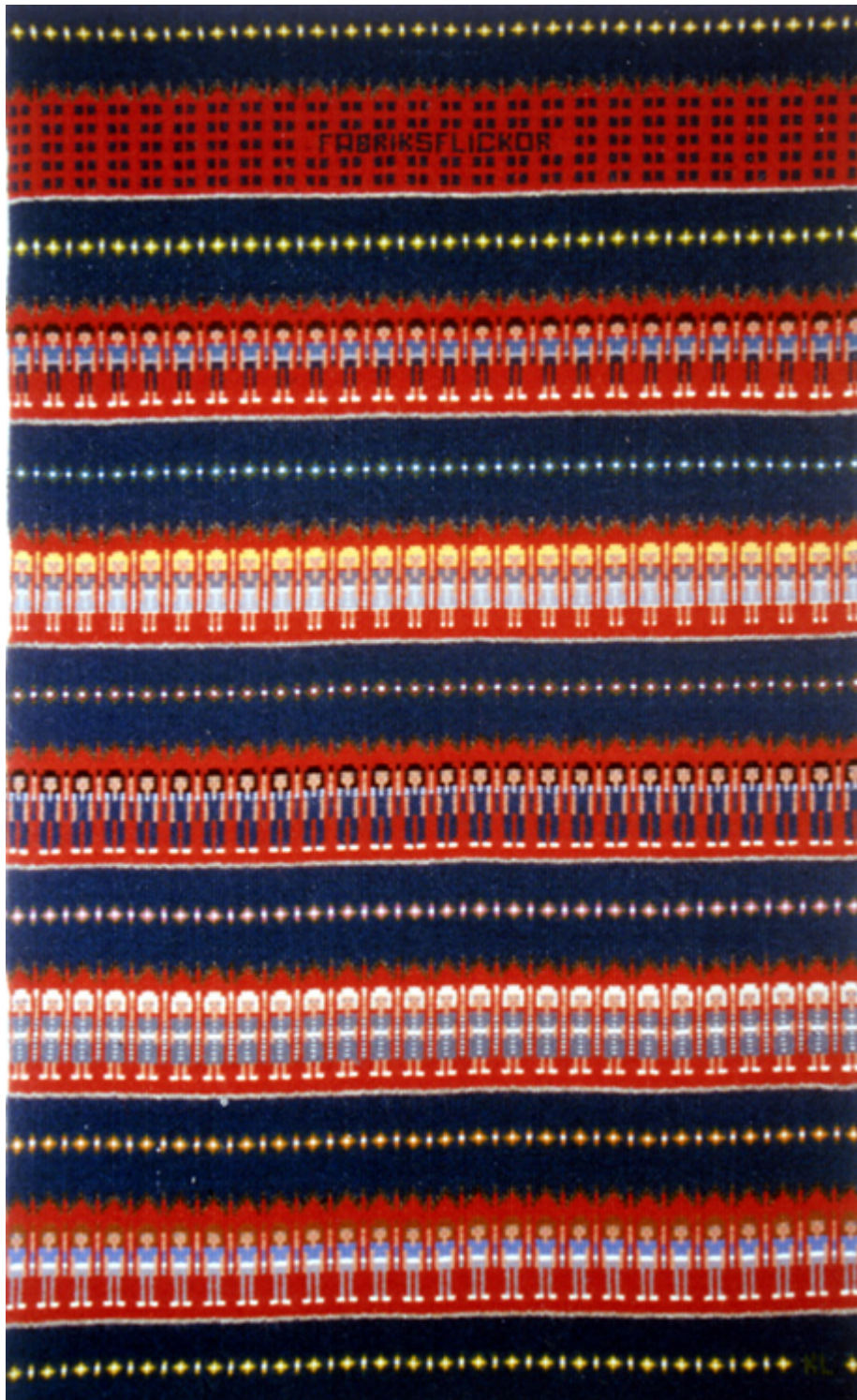

Kvinnor och TEKO

textilkonstnär katrin bawah

UTSTÄLLNINGAR

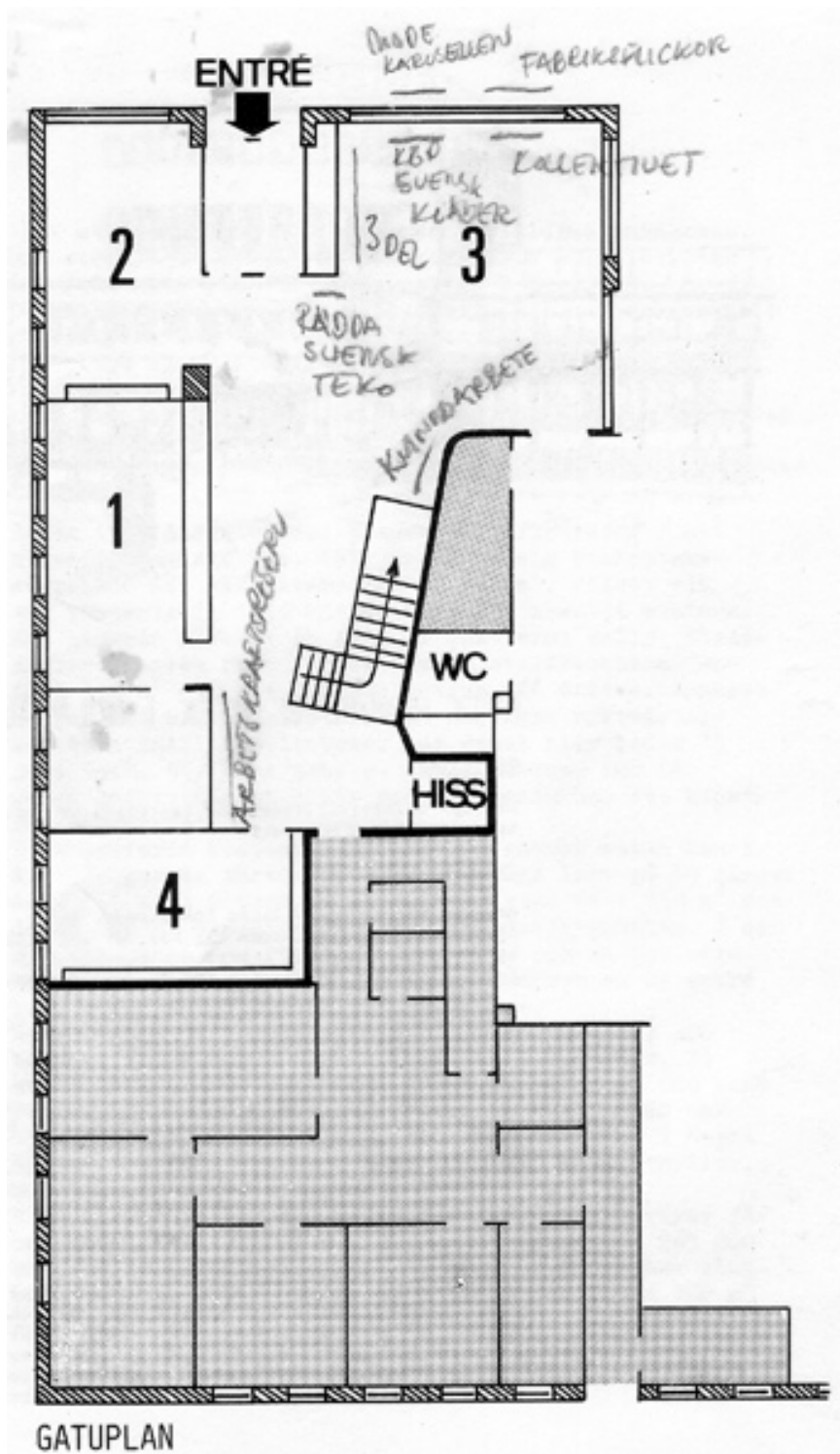

Kvinnor och TEKO

textilkonstnär katrin bawah